

Instruction Manual

HI 98311 • HI 98312

Waterproof EC/TDS/Temperature Testers

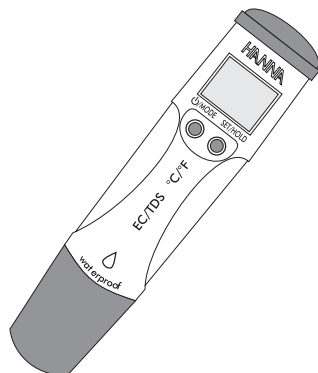

WARRANTY

HI 98311 and HI 98312 are warranted for one year against defects in workmanship and materials when used for their intended purpose and maintained according to instructions. The probe is warranted for a period of six months. This warranty is limited to repair or replacement free of charge.

Damages due to accident, misuse, tampering or lack of prescribed maintenance are not covered.

If service is required, contact the dealer from whom you purchased the instrument. If under warranty, report the model number, date of purchase, serial number and the nature of the failure. If the repair is not covered by the warranty, you will be notified of the charges incurred. If the instrument is to be returned to Hanna Instruments, first obtain a Returned Goods Authorization Number from the Customer Service department and then send it with shipment costs prepaid. When shipping any instrument, make sure it is properly packaged for complete protection.

All rights are reserved. Reproduction in whole or in part is prohibited without the written consent of the copyright owner, Hanna Instruments.

Hanna Instruments reserves the right to modify the design, construction and appearance of its products without advance notice.

Dear Customer,
Thank you for choosing a Hanna product. This manual will provide you with the necessary information for a correct operation. Please read it carefully before using the meter.
If you need additional technical information, do not hesitate to e-mail us at tech@hannainst.com.

These instruments are in compliance with the CE directives.

PRELIMINARY EXAMINATION

Remove the instrument from the packing material and examine it carefully. If any damage has occurred during shipment, immediately notify your Dealer or the nearest Hanna Customer Service Center.

Each meter is supplied with:

- HI 73311 EC/TDS probe
- HI 73128 probe removal tool
- batteries (4 x 1.5V) and instructions

Note: Conserve all packing material until the instrument has been observed to function correctly. Any defective item must be returned in its original packing.

US DESIGN PATENT
D462,024

GENERAL DESCRIPTION

HI 98311 and HI 98312 are waterproof EC/TDS and temperature meters. The housing has been completely sealed against humidity and designed to float.

All EC/TDS readings are automatically temperature compensated (ATC), and temperature values can be displayed in °C or °F units.

The EC/TDS conversion factor (CONV) is selectable by the user, as well as the temperature compensation coefficient β (BETA).

The meters can be calibrated at one point.

Measurements are highly accurate with a unique stability indicator right on the LCD.

A low battery symbol warns the user when the batteries are to be replaced. In addition the Battery Error Prevention System (BEPS) avoids erroneous reading caused by low voltage level by turning the meter off.

The HI 73311 EC/TDS probe, supplied with the meter, is interchangeable and can be easily replaced by the user.

The stainless steel encapsulated temperature sensor facilitates faster and more accurate temperature measurement and compensation.

FUNCTIONAL DESCRIPTION

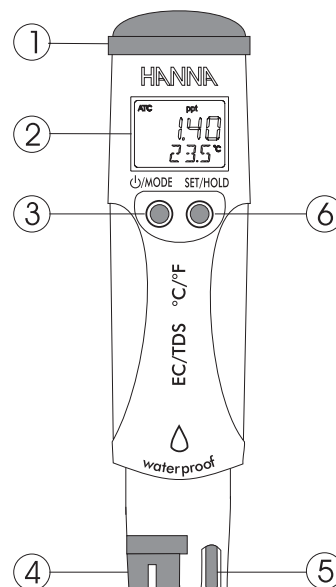

1. Battery compartment
2. Liquid Crystal Display (LCD)
3. ON/OFF/MODE button
4. HI 73311 EC/TDS probe
5. Temperature sensor
6. SET/HOLD button

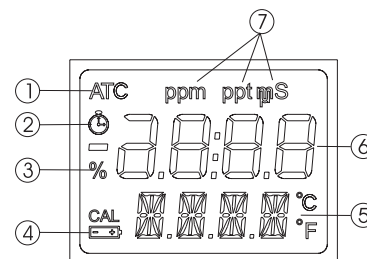

1. Automatic temperature compensation indicator
2. Stability indicator
3. Battery life percentage indicator
4. Low battery indicator
5. Secondary display
6. Primary display
7. Measuring units for primary display

SPECIFICATIONS

Range	0.0 to 60.0°C / 32.0 to 140.0°F 0 to 3999 µS/cm (HI 98311) 0.00 to 20.00 mS/cm (HI 98312) 0 to 2000 ppm (HI 98311) 0.00 to 10.00 ppt (HI 98312)
Resolution	0.1°C / 0.1°F 1 µS/cm ; 1 ppm (HI 98311) 0.01 mS/cm ; 0.01 ppt (HI 98312)
Accuracy	±0.5°C / ±1°F (@20°C/68°F) ±2% f.s. (EC/TDS)
Typical EMC	±0.5°C / ±1°F
Deviation	±2% f.s. (EC/TDS)
Temperature Compensation	Automatic, with $\beta=0.0$ to 2.4%/°C
Environment	0 to 50°C (32 to 122°F); RH 100%
TDS Factor	0.45 to 1.00 (CONV)
Calibration	Automatic, 1 point
Cal.Solutions	
HI 98311:	HI7031 (1413 µS/cm) HI7032 (1382 ppm; CONV=0.5) HI70442 (1500 ppm; CONV=0.7)
HI 98312:	HI7030 (12.88 mS/cm) HI70038 (6.44 ppt; CONV=0.5 or 9.02 ppt; CONV=0.7)
Probe (included)	HI 73311 EC/TDS probe
Battery Type/Life	4 x 1.5V with BEPS/approx. 100 hours
Auto-off	After 8 minutes of non-use
Dimensions	163 x 40 x 26 mm (6.4 x 1.6 x 1.0")
Weight	100 g (3.5 oz.)

Recommendations for Users

Before using this product, make sure that it is entirely suitable for the environment in which it is used. Operation of this instrument in residential areas could cause unacceptable interferences to radio and TV equipment. Avoid touching the probes at all times.

Any variation introduced by the user to the supplied equipment may degrade the instrument's EMC performance. To avoid electrical shock, do not use this instrument when voltages at the measurement surface exceed 24 Vac or 60 Vdc. To avoid damages or burns, do not perform any measurement in microwave ovens.

OPERATIONAL GUIDE

To turn the meter on and to check battery status

Press and hold the ϕ /MODE button for 2-3 seconds. All the used segments on the LCD will be visible for a few seconds, followed by a percent indication of the remaining battery life (E.g. % 100 BATT).

Taking measurements

Submerge the probe in the solution to be tested. Use plastic beakers to minimize any electromagnetic interferences.

Select either EC or TDS mode with the SET/HOLD button.

The measurements should be taken when the stability symbol \square on the top left of the LCD disappears.

The EC (or TDS) value automatically compensated for temperature is shown on the primary LCD while the secondary LCD shows the temperature of the sample.

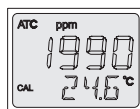

To change the temperature unit

To change the temperature unit (from °C to °F), from measurement mode, press and hold the ϕ /MODE button until TEMP and the current temperature unit are displayed on the lower portion of the LCD (E.g. TEMP °C).

Use the SET/HOLD button to change the temperature unit, and then press the ϕ /MODE button twice to return to the normal measuring mode.

To freeze the display

Press the SET/HOLD button for 2-3 seconds until HOLD appears on the secondary display.

Press either button to return to the normal measuring mode.

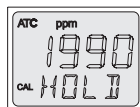

To turn the meter off

Press the ϕ /MODE button while in normal measuring mode. OFF will appear on the lower part of the display. Release the button.

Notes:

- Before taking any measurement make sure the meter has been calibrated.
- If measurements are taken in different samples successively, rinse the probe thoroughly to eliminate cross-contamination; and after cleaning, rinse the probe with some of the sample to be measured.

CALIBRATION

For better accuracy, frequent calibration of the instrument is recommended. In addition, the instrument must be recalibrated whenever:

- a) The EC/TDS probe is replaced.
- b) After testing aggressive chemicals.
- c) Where high accuracy is required.
- d) At least once a month.

To change the EC/TDS conversion factor (CONV) and the temperature compensation coefficient β (BETA)

- From measurement mode, press and hold the ϕ /MODE button until TEMP and the current temperature unit are displayed on the lower LCD (E.g. TEMP °C).
- Press the ϕ /MODE button again to show the current conversion factor (E.g. 0.50 CONV).
- Press the SET/HOLD button to change the conversion factor.
- Press the ϕ /MODE button to show the current temperature compensation coefficient β (E.g. 2.1 BETA).
- Press the SET/HOLD button to change the temperature compensation coefficient β .
- Press the ϕ /MODE button to return to the normal measuring mode.

Calibration procedure

- From measurement mode, press and hold the ϕ /MODE button until CAL is displayed on the lower LCD.
- Release the button and immerse the probe in the proper calibration solution: **HI 7031** (1413 μ S/cm) for **HI 98311** and **HI 7030** (12.88 mS/cm) for **HI 98312**.
- Once the calibration has been automatically performed, the LCD will display OK for 1 second and the meter will return to normal measurement mode.
- Since there is a known relationship between EC and TDS readings, it is not necessary to calibrate the meter in TDS. If the EC/TDS conversion factor is either 0.5 or 0.7, the meter will allow a direct calibration in ppm by using the Hanna calibration solutions listed below.

The CAL symbol on the LCD means that the meter is calibrated.

To reset to the default calibration

To clear a previous calibration, press the MODE button after entering the calibration mode. The lower LCD will display ESC for 1 second and the meter will return to normal measurement mode. The CAL symbol on the LCD will disappear. The meter will be reset to the default calibration.

PROBE MAINTENANCE

The EC/TDS probe can be easily replaced by using the supplied tool (**HI 73128**). Insert the tool into the probe cavity as shown below.

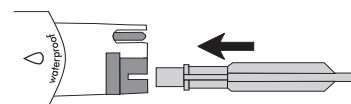

Rotate the probe counterclockwise.

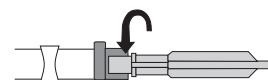

Pull the probe out by using the other side of the tool. Insert a new probe following the above instructions in reverse order.

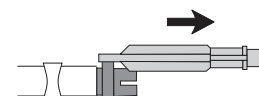

BATTERY REPLACEMENT

The meter displays the remaining battery percentage every time it is switched on. When the battery level is below 5%, the \square symbol on the bottom left of the LCD lights up to indicate a low battery condition. The batteries should be replaced soon. If the battery level is low enough to cause erroneous readings, the meter shows "0%" and the Battery Error Prevention System (BEPS) will automatically turn the meter off.

To change the batteries, remove the 4 screws located on the top of the meter.

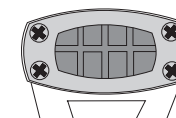

Once the top has been removed, carefully replace the 4 batteries located in the compartment while paying attention to their polarity.

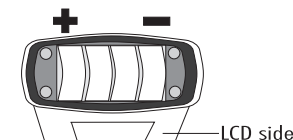

Replace the top, making sure that the gasket is properly seated in place, and tighten the screws to ensure a watertight seal.

ACCESSORIES

HI 73311	Replaceable EC/TDS probe
HI 73128	Probe removal tool
HI 70030P	12.88 mS/cm solution, 20 mL sachet (25 pcs)
HI 70031P	1413 μ S/cm solution, 20 mL sachet (25 pcs)
HI 70032P	1382 ppm solution, 20 mL sachet (25 pcs)
HI 70038P	6.44 ppt solution, 20 mL sachet (25 pcs)
HI 70442P	1500 ppm solution, 20 mL sachet (25 pcs)